

**IR-Lumineszenzdiode (850 nm) mit hoher Ausgangsleistung**  
**High Power Infrared Emitter (850 nm)**  
**Lead (Pb) Free Product - RoHS Compliant**  
**SFH 4550**



**Wesentliche Merkmale**

- Infrarot LED mit hoher Ausgangsleistung
- Enger Abstrahlwinkel  $\pm 3^\circ$
- Sehr hohe Strahlstärke
- Kurze Schaltzeiten
- UL Version erhältlich

**Anwendungen**

- Infrarotbeleuchtung für Kameras
- Sensorik
- Datenübertragung
- Rauchmelder

**Sicherheitshinweise**

Je nach Betriebsart emittieren diese Bauteile hochkonzentrierte, nicht sichtbare Infrarot-Strahlung, die gefährlich für das menschliche Auge sein kann. Produkte, die diese Bauteile enthalten, müssen gemäß den Sicherheitsrichtlinien der IEC-Normen 60825-1 und 62471 behandelt werden.

**Features**

- High Power Infrared LED
- Narrow emission angle  $\pm 3^\circ$
- Very high radiant intensity
- Short switching times
- UL version available

**Applications**

- Infrared Illumination for cameras
- Sensor technology
- Data transmission
- Smoke detectors

**Safety Advices**

Depending on the mode of operation, these devices emit highly concentrated non visible infrared light which can be hazardous to the human eye. Products which incorporate these devices have to follow the safety precautions given in IEC 60825-1 and IEC 62471.

Typ Type	Bestellnummer Ordering Code	Strahlstärkegruppierung <sup>1)</sup> ( $I_F = 100 \text{ mA}$ , $t_p = 20 \text{ ms}$ ) Radiant Intensity Grouping <sup>1)</sup> $I_e$ (mW/sr)
SFH 4550	Q65110A1772	$\geq 400$ (typ. 700)

<sup>1)</sup> gemessen bei einem Raumwinkel  $\Omega = 0.001 \text{ sr}$  / measured at a solid angle of  $\Omega = 0.001 \text{ sr}$

**Grenzwerte** ( $T_A = 25\text{ °C}$ )**Maximum Ratings**

Bezeichnung Parameter	Symbol Symbol	Wert Value	Einheit Unit
Betriebs- und Lagertemperatur Operating and storage temperature range	$T_{op}, T_{stg}$	- 40 ... + 100	°C
Sperrspannung Reverse voltage	$V_R$	5	V
Vorwärtsgleichstrom Forward current	$I_F$	100	mA
Stoßstrom, $t_p = 10\ \mu\text{s}$ , $D = 0$ Surge current	$I_{FSM}$	1.5	A
Verlustleistung Power dissipation	$P_{tot}$	180	mW
Wärmewiderstand Sperrschicht - Umgebung bei Montage auf FR4 Platine, Padgröße je $16\ \text{mm}^2$ Thermal resistance junction - ambient mounted on PC-board (FR4), padsize $16\ \text{mm}^2$ each	$R_{thJA}$	450	K/W

**Kennwerte** ( $T_A = 25\text{ °C}$ )**Characteristics**

Bezeichnung Parameter	Symbol Symbol	Wert Value	Einheit Unit
Wellenlänge der Strahlung Wavelength at peak emission $I_F = 100\ \text{mA}$	$\lambda_{peak}$	860	nm
Centroid-Wellenlänge der Strahlung Centroid wavelength $I_F = 100\ \text{mA}$	$\lambda_{centroid}$	850	nm
Spektrale Bandbreite bei 50% von $I_{max}$ Spectral bandwidth at 50% of $I_{max}$ $I_F = 100\ \text{mA}$	$\Delta\lambda$	42	nm
Abstrahlwinkel Half angle	$\varphi$	$\pm 3$	Grad deg.
Aktive Chipfläche Active chip area	$A$	0.09	$\text{mm}^2$
Abmessungen der aktiven Chipfläche Dimension of the active chip area	$L \times B$ $L \times W$	$0.3 \times 0.3$	$\text{mm}^2$

Kennwerte ( $T_A = 25\text{ °C}$ )

Characteristics (cont'd)

Bezeichnung Parameter	Symbol Symbol	Wert Value	Einheit Unit
Schaltzeiten, $I_e$ von 10% auf 90% und von 90% auf 10%, bei $I_F = 100\text{ mA}$ , $R_L = 50\ \Omega$ Switching times, $I_e$ from 10% to 90% and from 90% to 10%, $I_F = 100\text{ mA}$ , $R_L = 50\ \Omega$	$t_r, t_f$	12	ns
Durchlassspannung Forward voltage $I_F = 100\text{ mA}$ , $t_p = 20\text{ ms}$ $I_F = 1\text{ A}$ , $t_p = 100\ \mu\text{s}$	$V_F$ $V_F$	1.5 (< 1.8) 2.4 (< 3.0)	V V
Sperrstrom Reverse current	$I_R$	not designed for reverse operation	$\mu\text{A}$
Gesamtstrahlungsfluss Total radiant flux $I_F = 100\text{ mA}$ , $t_p = 20\text{ ms}$	$\Phi_{e\text{ typ}}$	50	mW
Temperaturkoeffizient von $I_e$ bzw. $\Phi_e$ , $I_F = 100\text{ mA}$ Temperature coefficient of $I_e$ or $\Phi_e$ , $I_F = 100\text{ mA}$	$TC_I$	- 0.5	%/K
Temperaturkoeffizient von $V_F$ , $I_F = 100\text{ mA}$ Temperature coefficient of $V_F$ , $I_F = 100\text{ mA}$	$TC_V$	- 0.7	mV/K
Temperaturkoeffizient von $\lambda$ , $I_F = 100\text{ mA}$ Temperature coefficient of $\lambda$ , $I_F = 100\text{ mA}$	$TC_\lambda$	+ 0.3	nm/K

**Strahlstärke  $I_e$  in Achsrichtung<sup>1)</sup>**gemessen bei einem Raumwinkel  $\Omega = 0.001$  sr**Radiant Intensity  $I_e$  in Axial Direction**at a solid angle of  $\Omega = 0.001$  sr

Bezeichnung Parameter	Symbol	Werte Values			Einheit Unit
		SFH 4550-DW	SFH 4550-EW	SFH 4550-FW	
Strahlstärke Radiant intensity $I_F = 100$ mA, $t_p = 20$ ms	$I_{e \text{ min}}$ $I_{e \text{ max}}$	400 800	630 1250	1000 2000	mW/sr mW/sr
Strahlstärke Radiant intensity $I_F = 1$ A, $t_p = 100$ $\mu$ s	$I_{e \text{ typ}}$	5000	7000	9000	mW/sr

<sup>1)</sup> Nur eine Gruppe in einer Verpackungseinheit (Streuung kleiner 2:1) /  
Only one group in one packing unit (variation lower 2:1)

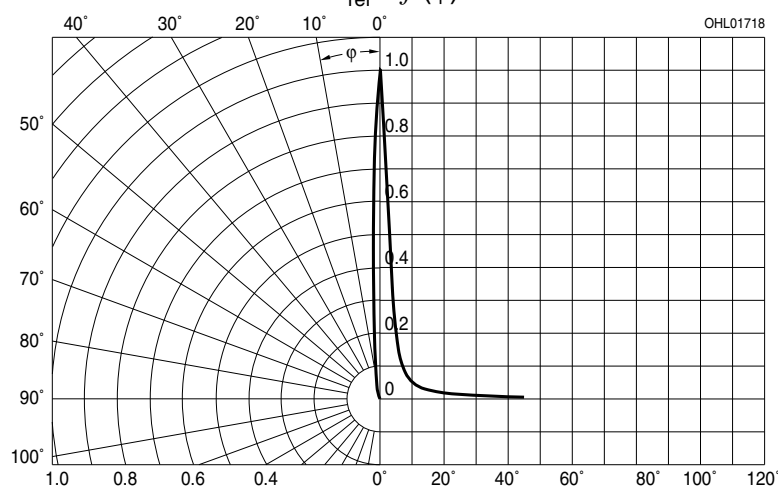
**Abstrahlcharakteristik****Radiation Characteristics  $I_{\text{rel}} = f(\varphi)$** 

**Relative Spectral Emission**

$I_{rel} = f(\lambda)$

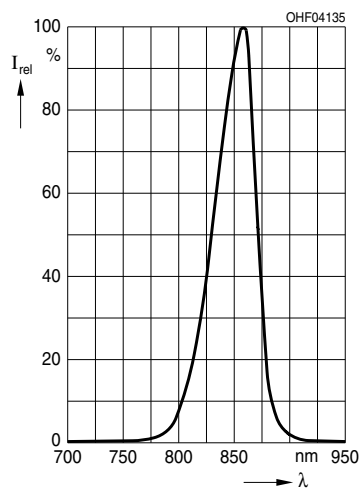

**Radiant Intensity**  $\frac{I_e}{I_e 100 \text{ mA}} = f(I_F)$

Single pulse,  $t_p = 20 \mu\text{s}$

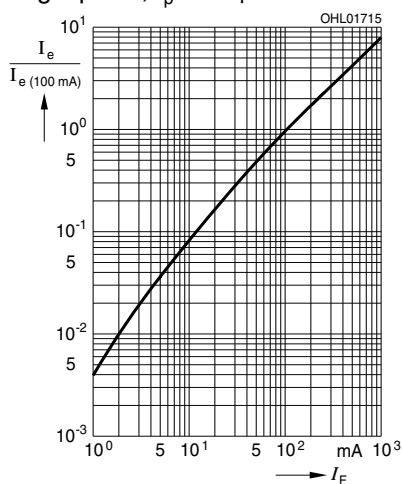

**Max. Permissible Forward Current**

$I_F = f(T_A), R_{thJA} = 450 \text{ K/W}$

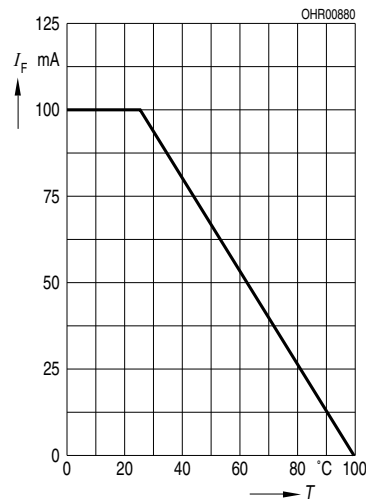

**Forward Current**  $I_F = f(V_F)$

Single pulse,  $t_p = 20 \mu\text{s}$

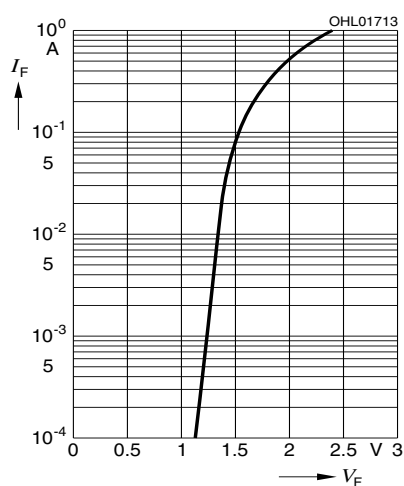

**Permissible Pulse Handling Capability**

$I_F = f(\tau), T_A = 25^\circ\text{C}$ , duty cycle  $D = \text{parameter}$

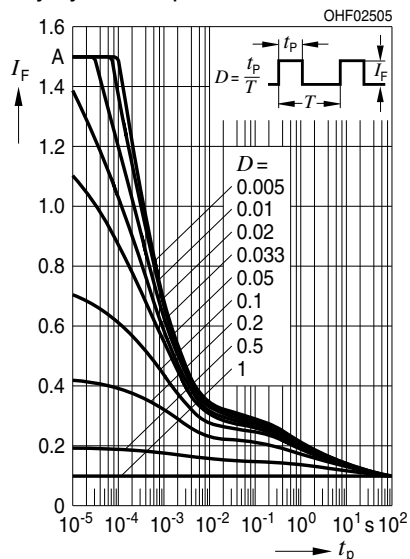

**Maßzeichnung  
Package Outlines**

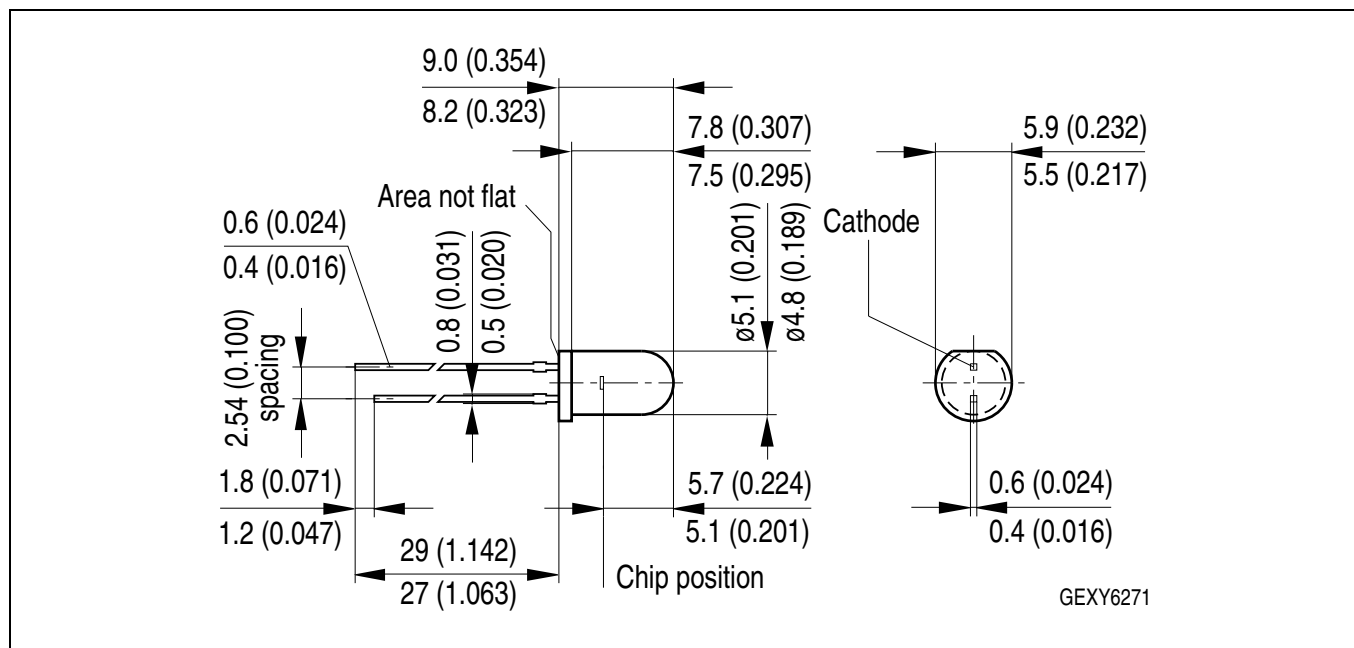

Maße in mm (inch) / Dimensions in mm (inch).

**Empfohlenes Lötpad Design  
Recommended Solder Pad Design**

**Wellenlöten TTW  
TTW Soldering**

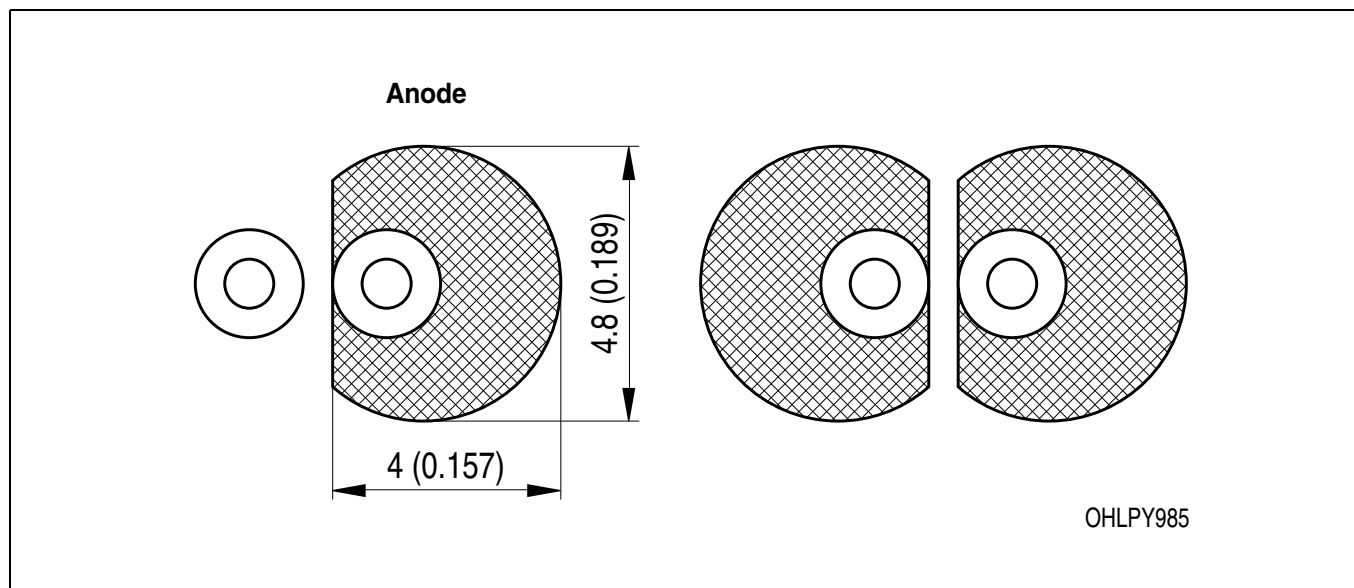

Maße in mm (inch) / Dimensions in mm (inch).

**Lötbedingungen**  
**Soldering Conditions**  
**Wellenlöten (TTW)**  
**TTW Soldering**

(nach CECC 00802)  
(acc. to CECC 00802)

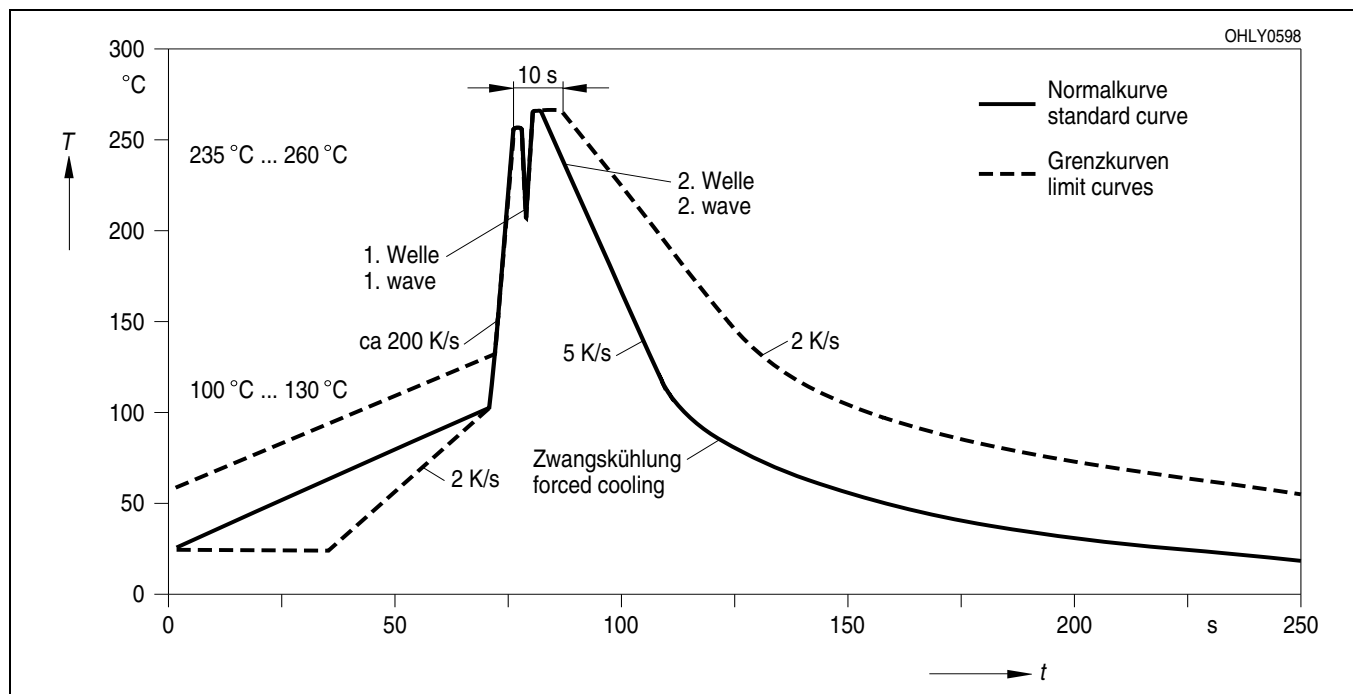

Published by  
**OSRAM Opto Semiconductors GmbH**  
Leibnizstraße 4, D-93055 Regensburg  
[www.osram-os.com](http://www.osram-os.com)  
© All Rights Reserved.

The information describes the type of component and shall not be considered as assured characteristics. Terms of delivery and rights to change design reserved. Due to technical requirements components may contain dangerous substances. For information on the types in question please contact our Sales Organization.

**Packing**

Please use the recycling operators known to you. We can also help you – get in touch with your nearest sales office. By agreement we will take packing material back, if it is sorted. You must bear the costs of transport. For packing material that is returned to us unsorted or which we are not obliged to accept, we shall have to invoice you for any costs incurred.

**Components used in life-support devices or systems must be expressly authorized for such purpose!** Critical components<sup>1</sup>, may only be used in life-support devices or systems<sup>2</sup> with the express written approval of OSRAM OS.

<sup>1</sup> A critical component is a component used in a life-support device or system whose failure can reasonably be expected to cause the failure of that life-support device or system, or to affect its safety or effectiveness of that device or system.

<sup>2</sup> Life support devices or systems are intended (a) to be implanted in the human body, or (b) to support and/or maintain and sustain human life. If they fail, it is reasonable to assume that the health of the user may be endangered.

EU RoHS and China RoHS compliant product



此产品符合欧盟 RoHS 指令的要求；

按照中国的相关法规和标准，不含有毒有害物质或元素。

# Mouser Electronics

## Related Product Links

[720-SFH4550 - Osram Opto Semiconductor SFH 4550](#)